

CONNECT unlimited. ALLES IST MÖGLICH.

CONNECT unlimited. EVERYTHING IS POSSIBLE.



CONNECT unlimited.
EVERYTHING IS POSSIBLE.

made by MAHA
made
in
Germany



CONNECT SERIES

ONLY PROS, NO CONS

- Our ultimate aim when developing the test stand was maximum availability for our customers in terms of fail safety. This guarantees an extremely robust floor assembly in conjunction with components of the highest quality.
- Another unparalleled product advantage is the modular design of the test stand which guarantees the future viability and development of our customers.
- A unique-to-the-industry “end-of-line” test – i.e. each function of the test stand is put through its paces before every delivery – guaranteeing a high degree of certainty for customers when it comes to start-up and commissioning.
- All options and sensors can be plugged in thanks to plug & play technology, guaranteeing extremely quick and straightforward maintenance.
- Taking into account all these factors, we can safely say that technology and quality have prevailed and that this product has the potential to make our customers very successful.
- Join us on our path towards a digital future – **CONNECT unlimited**. EVERYTHING IS POSSIBLE. We look forward to seeing you.

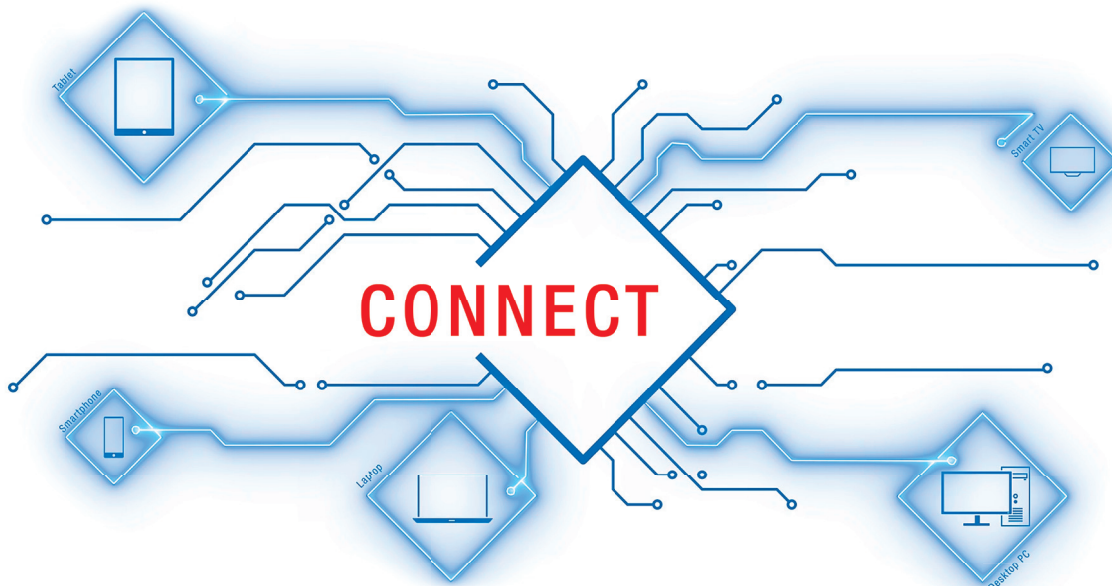

CONNECT – Video

THE PRODUCT RANGE

CAR

AXLE LOAD	VERSION*		TRACK WIDTH (MAX.)	DRIVE POWER	MODEL NAME
3500 kg	C		2200 mm	3 kW	C_MBT C 3.5 W220
			2500 mm		C_MBT C 3.5 W250
	S		2200 mm		C_MBT S 3.5 W220
4000 kg	C		2200 mm	4 kW	C_MBT C 4.0 W220
			2500 mm		C_MBT C 4.0 W250
	S		2200 mm		C_MBT S 4.0 W220
5000 kg	C		2800 mm	4 kW	C_MBT C 5.0 W280
	S		2800 mm		C_MBT S 5.0 W280

* Version: C = Compact (one-part roller set)
S = Split (two-part roller set)

10 OUT OF 10 REASONS TO BUY A **CONNECT** unlimited.

A STURDY AND SOLID DESIGN

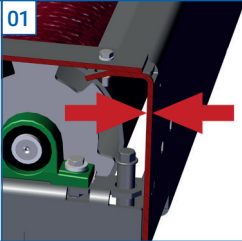

01 Robust roller set made from 6 mm sheet steel

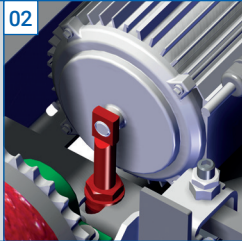

02 Double bearing system and splash-resistant motors

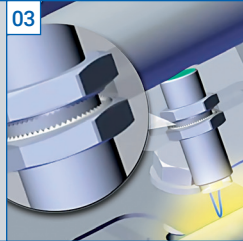

03 Self-locking NAMUR switches with status LED in metal design

10

MODULAR INTERFACE MODULE IN THE FLOOR ASSEMBLY

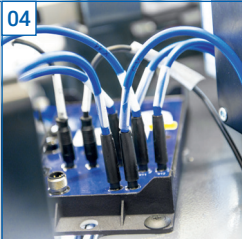

04 Plug & play for all sensors and options thanks to the plug & play technology



05 Encased, splash-resistant and almost completely waterproof interface module



06 All options for expanding to a test lane or with weighing devices can be easily retrofitted

SECURE AND DIGITAL DATA TRANSMISSION



07 Sensor technology with function diagnostics



08 Conversion of measurement values into digital signals via interface module



09 Undisrupted CAN bus transmission even over long distances

01

09

02

03

07

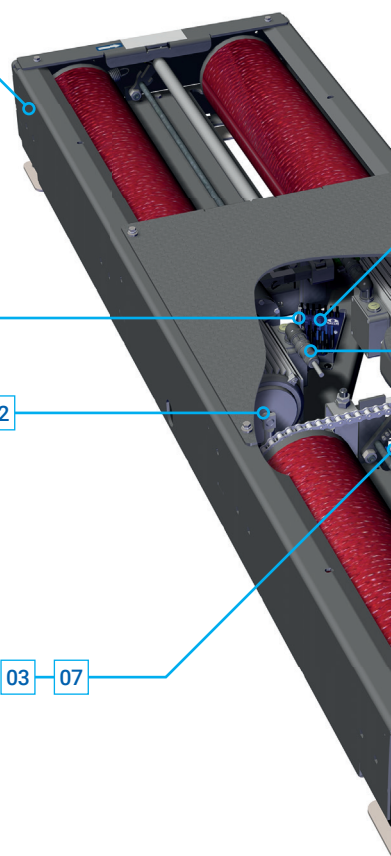



MODULAR CABINET SET-UP

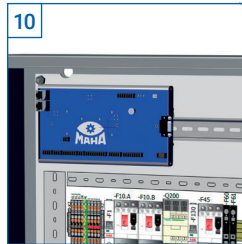

Modular set-up of the cabinet with one central module for all versions

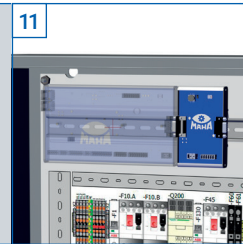

Upgrade any time with plug-in optional modules



Flexible installation options: on the wall or on universal console (decentrally too)

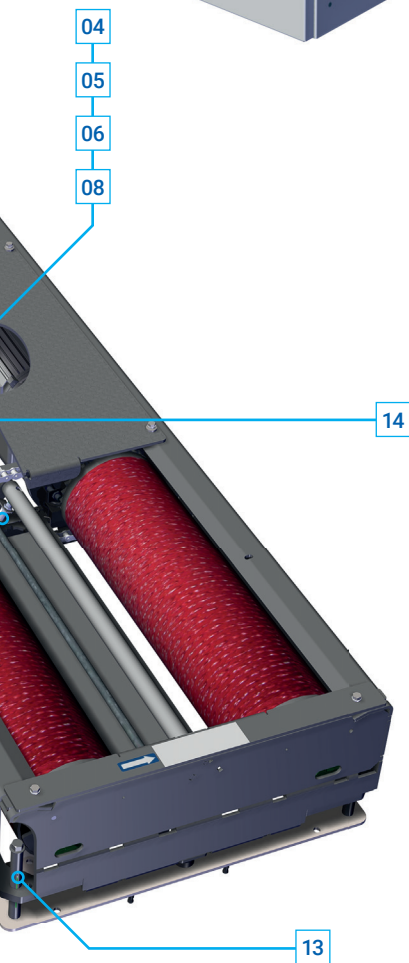

MULTI-FLEXIBLE DISPLAY POSSIBILITIES "unlimited"



"Bring your own device" (smartphone, tablet, notebook, PC, smart TV...)



Option of wireless connection via WiFi or wired connection via LAN



Browser-based display (no software or app installation necessary)

SIMPLE START-UP

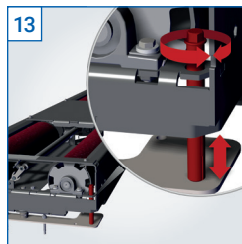

The height of the brake tester is easily adjustable to ground level (patent pending)

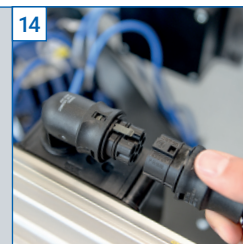

Easy plug-in connection of the CAN data bus (four wire) and drive motors

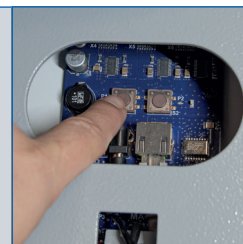

Very easy pairing of display units, wirelessly or connected via network cable

10 OUT OF 10 REASONS TO BUY A **CONNECT** unlimited.

SIMPLE MAINTENANCE AND SERVICE



15 All sensors are easy to diagnose and can be plugged into the roller set on the interface module



16 Personalised access, fault diagnosis and log function via web browser (no software required)



16 Easy remote maintenance via integrated data interfaces

16 17 19

SAFE OPERATION



17 Already meets all current and planned safety standards, for example

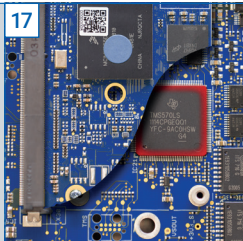

17 High degree of application safety using independent safety controller

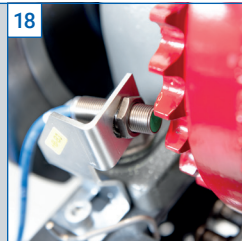

18 Best possible tyre-saving thanks to "real" slip monitoring by electronic sensor technology

OPTIMISED CALIBRATION AND ADJUSTMENT



18 User administration with individually configurable access permissions



18 Simple user-guided calibration and adjustment via web browser

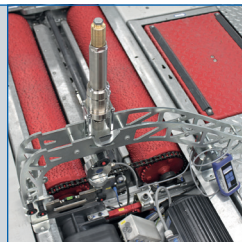

18 Integration of further test lane equipment in the calibration and adjustment menu

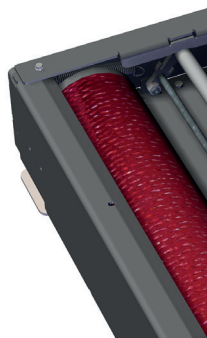
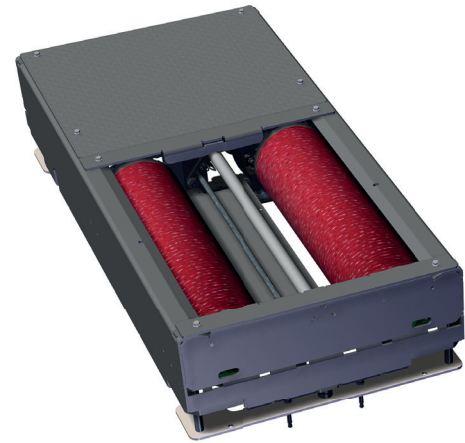

18



INTEGRATED AND EXPANDABLE SOFTWARE AND/OR INTERFACES



Full functionality even without internet connection and PC



Connection to EUROSYS-TEM V8 easily possible

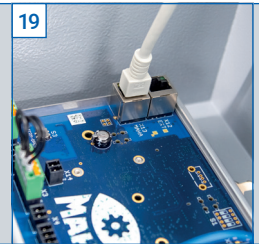

Two network/data interfaces for example, ASA live-stream, internet link-in, network printers,...
(ES IN/OUT, JSON,... – coming soon)

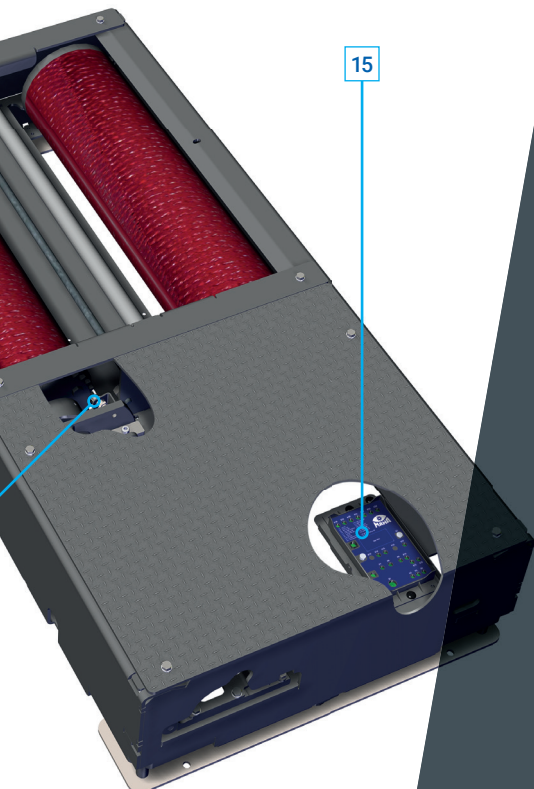

PRODUCT RECOMMENDATION

Should I choose a brake tester with 3.5 t axle load / 3 kW or one with 4.0 t and 4 kW?

This question is relatively easy to answer.

The 3.5 t / 3 kW version is an absolutely full-fledged brake tester, which is particularly suitable for independent workshops, OEM workshops and testing organisations that expect normal testing volumes and primarily test vehicles with an average total weight.

The version with 4.0 t / 4 kW motors is the right product for independent workshops, OEM workshops and testing organisations that have a high-frequency vehicle throughput or also test vehicles with a rather above-average total weight.

The main difference between the two versions is the higher torsional rigidity and traversability of the floor assembly as well as the more powerful drive motors, which have a higher stability.

Increasing technology, safety equipment and extras, as well as the growing trend towards electromobility and large vehicle categories such as SUVs, mean that vehicle weight will continue to rise in the future.

We recommend that you also take this into account when deciding on an investment for the next ten years.

*With compliments
Your MAHA Team*

OPTIONS (excerpt)



Roller set cover, optionally removable or hinged opening outwards

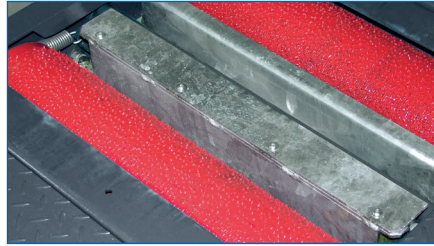

Automatic drive-over/lowering bar

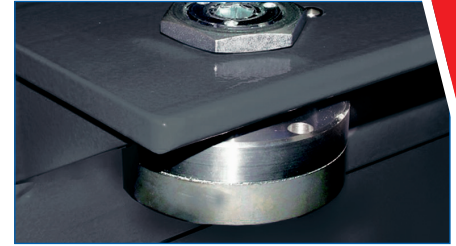

Weighing device



ASA Livestream (External data interface, e.g. for WiFi access point)



Pedal force meter, model: C_PFM 1000



Radio remote control, model: C_RECO S



Roller surface plastic/granulate coated



Universal analog display, model: C_MSA



Wall mount for analog display or LCD simultaneous display unit



C_Tablet-PC Rugged (industry and military standard)



Software: EUROSISTEM V8 CONNECT

MAHA Maschinenbau Haldenwang GmbH & Co. KG
Hoyen 20
87490 Haldenwang
Germany

maha.de